

Air Knight[®] WITH **IPG**
AIR PURIFICATION SYSTEM IONIZED PARTICLE GATHERING



OWNER'S MANUAL

www.airknightiaq.com

THANK YOU

for your purchase of the Air Knight IPG in-duct air purification system. This unit is designed to be installed into a central HVAC system and provide virtually maintenance free air purification.

Please read and follow all service procedures outlined in this manual.

Please record the name and phone of your installing contractor.

Name _____

Phone _____

Please record the serial number of your Air Knight® system.

Serial Number _____

CONTENTS

Product Contents	3
Installation Hardware	3
Replacement Parts	3
Specifications	4
About Air Knight IPG	4
Recommended Installation Tools	5
Installation Requirements	5
Metal Ductwork Installation	6
Fiberglass Ductwork Installation	8
Maintenance/UV Lamp Indicator	10
Disposal of IPG Core	10
Changing of IPG Core	11
Limited Warranty	13
Notes	14

PRODUCT CONTENTS

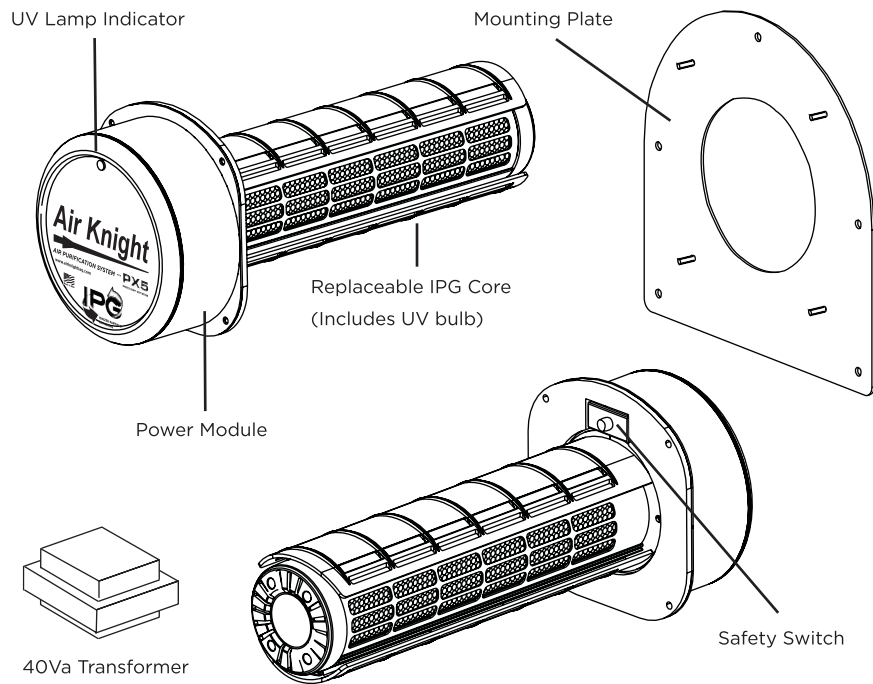

INSTALLATION HARDWARE

- (5) 3/4" #8 Self-Tapping Screws w/ 1/4" Hex Head
- (5) 3" Threaded Bolts w/Phillips Head
- (5) Butterfly Toggle Bolt Anchors
- (6) 18-22 Gauge Wire Screw-On Nuts
- (2) 1/2" #10 Self-Tapping Screws w/ 5/16" Hex Head
- (4) 1/2" Brass Knurled Thumb Nuts #8-32
- (4) #8 Star Lock Washers

REPLACEMENT PARTS

- 14" IPG Core (Includes UV Bulb) - #TT-IPG-CELL14
- 7" IPG Core (Includes UV Bulb) - #TT-IPG-CELL7



ABOUT AIR KNIGHT IPG



ABOUT AIR KNIGHT IPG

The Air Knight IPG in-duct air purification system is a new generation HVAC air system designed to reduce odors, smoke, germs, and a broad spectrum of indoor air contaminants.

The Air Knight IPG in-duct air purification system is easily mounted into HVAC system air ducts where many air quality problems can start. Using a unique technology, the Air Knight IPG system uses UV light energy to illuminate a quint-metallic core to produce ionic oxidizers that seek out and attack indoor pollutants. These ionic "air scrubbers" clean the air AND surfaces wherever the air goes.

SPECIFICATIONS

12" Cell

Dimensions

Unit: 6"H x 6"W x 14.6"L
Mounting Plate: 8"H x 8"W

Electrical

AC 24V 50/60 Hz.

Power Consumption

14 Watts.

Weight

Approx. 3lbs.

7" Cell

Dimensions

Unit: 6"H x 6"W x 9.65"L
Mounting Plate: 8"H x 8"W

Electrical

AC 24V 50/60 Hz.

Power Consumption

13 Watts.

Weight

Approx. 3lbs.

WARNINGS & IMPORTANT INFORMATION



The device must be installed in compliance with all national and local electrical and mechanical codes. Failure to do so will void the warranty.



UV Light in operation. Disconnect unit from power supply before servicing. Failure to follow warnings may result in severe eye damage.

INSTALLATION (Tools & Requirements)

RECOMMENDED INSTALLATION TOOLS

- 4" Hole Saw (metal specific recommended)
- Drill/Power Driver
- Phillips Screwdriver
- 3/8" Drill Bit (for fiberglass ductwork)
- 1/4" Nut Driver Bit

YOU MAY ALSO NEED:

- Utility Knife or Duct Knife
- Tin Snips (for metal ductwork)

INSTALLATION REQUIREMENTS

1. Unit should be installed in the supply side air stream of the HVAC system.
2. An approximate 4" (8.89 cm) opening will need to be cut into the existing duct work to install the unit properly.

Airflow Orientation

Be sure to orient the unit for proper airflow through the IPG core in either horizontal or vertical air flow systems. Air should be able to freely flow through the IPG core as shown.

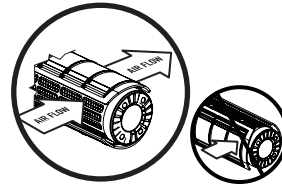

It is recommended that the Fan Setting on your thermostat be set to ON to ensure continuous air flow through the IPG core.

REMOVE AIRFLOW TAG BEFORE INSTALLATION

Hardwiring Requirements

Connect black and white wires to a dedicated 40Va transformer.



Electrical wiring of the unit to the HVAC system should be done by a licensed HVAC installer or electrical contractor.

INSTALLATION (Metal Ductwork)



- STEP 1** Locate a suitable area of the supply side duct before the first branch for installation, near a power source.
Cut away insulation to expose metal duct. (If needed)



- STEP 2** Using your mounting plate, trace the existing 4" hole for your cell to be placed through.



- STEP 3** Use your drill and 4" circular bit to cut the traced hole out OR use the [Alternative Cutting Method](#).



- STEP 4** Secure the mounting plate using (5) self-tapping screws.



ALTERNATIVE CUTTING METHOD

- STEP 1** Drill 4 holes along the outside of the traced circle.

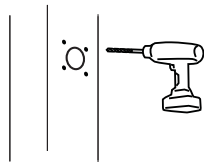

- STEP 2** Cut a square out around the hole using tin snips.

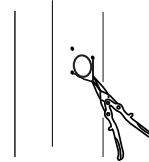

INSTALLATION (Metal Ductwork)

STEP 5

Insert your unit into the opening, making sure the air will pass through the core as shown on Page 5.



Airflow Orientation

Be sure to orient the unit for proper airflow through the IPG core in either horizontal or vertical air flow systems. Air should be able to freely flow through the IPG core as shown.

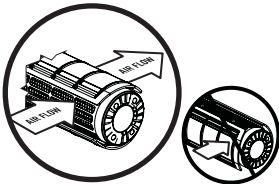

If the core has been oriented in the other direction place the supplied cover label on the front of your unit to reflect this change.

STEP 6

Secure the unit to the mounting plate with (4) Knurled Nuts.



STEP 7

Connect to 24V Power Source.



INSTALLATION (Fiberglass Ductwork)



STEP 1

Locate a suitable area of the supply side duct before the first branch for installation, near a power source.



STEP 2

Using your mounting plate, trace the existing 4" hole for your cell to be placed through. Also, mark the locations of the (5) screw holes along the edges.



STEP 3

Cut Hole in duct using your 4" Hole Saw OR with a duct knife.



STEP 4

Drill the mounting holes using a 3/8" Drill Bit.



STEP 5

Insert (5) 3" Threaded Bolts into screw holes of mounting plate. Attach (5) Toggle Bolt Anchors to the ends of the Threaded Bolts.



INSTALLATION (Fiberglass Ductwork)

**STEP
6**

Insert Toggle Bolts into 3/8" holes in duct. Be sure the Toggle Anchors open after inserting.

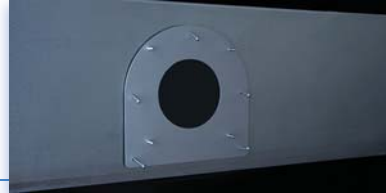

**STEP
7**

Tighten Toggle Bolts

DO NOT OVERTIGHTEN

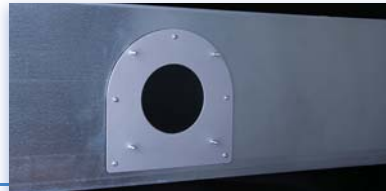

**STEP
8**

Insert your unit into the opening, making sure the air will pass through the core as shown on Page 5.



**STEP
9**

Secure the unit to the mounting plate with (4) Knurled Nuts



**STEP
10**

Connect to 24V Power Source.



MAINTENANCE



MAINTENANCE/UV LAMP INDICATOR

For optimal performance, replace the IPG Core w/UV Lamp every 2 years and the UV lamp every 2 years, even if the UV lamp appears to be operating normally.

The UV lamp operation indicator on the face of the unit will glow when the UV lamp is in use. If the indicator does not glow and the unit has power, the IPG Core should be replaced.

The ionization system should be inspected annually. Any buildup of dust should be wiped clean on the exterior and compressed air used to remove dust accumulated underneath the shroud and around the ionization system, if necessary.

UV Lamp Indicator



DISPOSAL OF THE IPG CORE AND UV LAMP

DO NOT THROW YOUR IPG CORE IN THE TRASH.

Dispose of the spent IPG Core and UV lamp at your local recycling center. You may also send your spent IPG Core and UV lamp, in the same container you received your replacement, to:

Air Knight Reclamation
1112 Industrial Drive
Royse City, TX 75189

Hg-LAMP CONTAINS MERCURY. Manage in accordance with disposal laws.
See www.lamprecycle.org

MAINTENANCE

CHANGING THE IPG CORE

STEP 1

Disconnect power to the unit.



STEP 2

Remove the Mounting Nuts.



STEP 3

Remove the unit from the Mounting Plate.



STEP 4

Remove the (2) Screws from the IPG Core.



STEP 5

Separate the used core from the base unit and dispose of properly.



MAINTENANCE



CHANGING THE IPG CORE (Continued)

STEP 6

Plug the new IPG Core into the base unit.

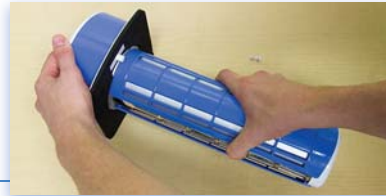

STEP 7

Secure with (2) Screws and remove the airflow tag from the IPG Core.



STEP 8

Insert your unit into the opening, making sure the air will pass through the core as shown on Page 5.



STEP 9

Secure the unit with Nuts



STEP 10

Reconnect the Power Supply or Power Source.



LIMITED WARRANTY

Dust Free®, LP (Dust Free) warrants to the original purchaser that the Air Knight IPG (other than the IPG Core and the UV Lamp) shall be free from defect in material and workmanship under normal use and service, for a period of five (5) years from the date of original purchase. Dust Free warrants to the original purchaser that the IPG Core shall be free from defect in material and workmanship under normal use and service, for a period of four (4) years from the date of original purchase. Dust Free warrants to the original purchaser that the UV Lamp shall be free from defect in material and workmanship under normal use and service, for a period of two (2) years from the date of original purchase. Dust Free's obligation under this warranty shall be limited to repair or replacement of those goods which prove defective, provided that such products are installed, maintained, and operated for the purpose and in the manner intended and for which Dust Free instructs or recommends. Neither Dust Free nor its dealers shall be liable for any special or consequential damages directly or indirectly arising from the design, construction, installation, servicing, or operation of the goods. SOME STATES DO NOT ALLOW THE EXCLUSION OR LIMITATION OF INCIDENTAL OR CONSEQUENTIAL DAMAGES, SO THE ABOVE EXCLUSION MAY NOT APPLY TO YOU. THIS IS DUST FREE'S SOLE WARRANTY AND THERE ARE NO WARRANTIES THAT EXTEND BEYOND THE DESCRIPTION ON THE FACE HEROF. NEITHER DUST FREE NOR ITS DEALERS MAKE ANY OTHER WARRANTY OF ANY KIND, EXPRESS OR IMPLIED. ALL IMPLIED WARRANTIES OF MERCHANTABILITY AND FITNESS FOR A PARTICULAR PURPOSE WHICH EXCEED DUST FREE'S AFFORESTATED OBLIGATIONS ARE HEREBY DISCLAIMED AND EXCLUDED FROM THIS WARRANTY. SOME STATES DO NOT ALLOW LIMITATIONS ON HOW LONG AN IMPLIED WARRANTY LASTS, SO THE ABOVE LIMITATION MAY NOT APPLY. THIS WARRANTY GIVES YOU SPECIFIC LEGAL RIGHTS, AND YOU MAY ALSO HAVE OTHER RIGHTS WHICH VARY FROM STATE TO STATE. DUST FREE'S AND ITS DEALER'S LIABILITY UNDER THIS WARRANTY SHALL IN NO EVENT EXCEED THE COST OF THE GOODS SOLD UNDER THE CONTRACT OF SALE.

Dust Free neither assumes, nor authorizes any person to assume for it, any obligation in connection with the goods. This warranty shall not apply to any goods: (a) which have been subjected to misuse, tampering, negligence, or accidents; (b) the serial numbers of which have been altered, defaced, or removed; or (c) which have been used in a manner contrary to Dust Free's instructions or recommendations. This warranty may not be assigned or transferred. If any portion of this limited warranty is held illegal or unenforceable by reason of any law, such partial illegality or unenforceability shall not affect the enforceability of the remainder of this limited warranty.

For Warranty Claims:

By Telephone: Call Dust Free® at 1-972-635-2323, and ask to speak with a Customer Service Representative regarding a potential Warranty Claim. The Customer Service Representative will provide further instructions.

By Website: Visit Dust Free's website at www.dustfree.com and click on the "Contact" link to report a potential Warranty Claim. A Customer Service Representative will reply by email and will provide further instructions.

Dust Free®, LP, PO Box 519, Royse City, TX 75189. Please do not mail Warranty Claim requests or your product to this address. Warranty Claim requests are only accepted by telephone and through the website.

Include a copy of your Bills of Sale, Invoice or Receipt of Purchase, with an explanation of the problem or defect.



NOTES



NOTES



www.airknightiaq.com